

MISCELLANEOUS

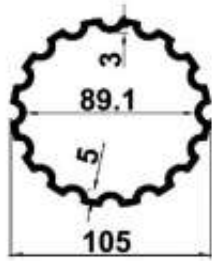

SI NO	SECTION NO.	WEIGHT(KG/M)
1	2112	3.137

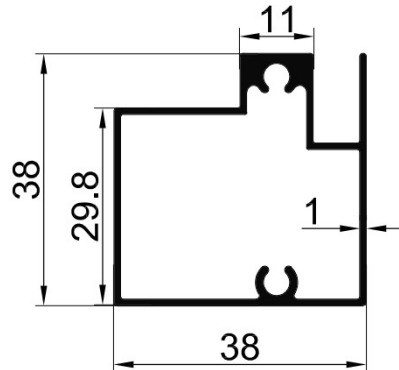

SI NO	SECTION NO.	WEIGHT(KG/M)
1	1139	0.547

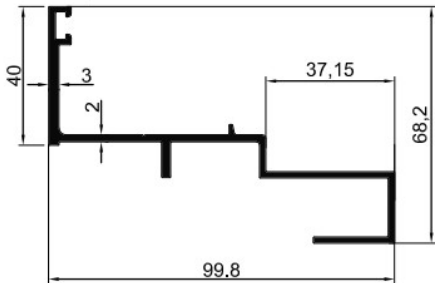

SI NO	SECTION NO.	WEIGHT(KG/M)
1	2734	1.176

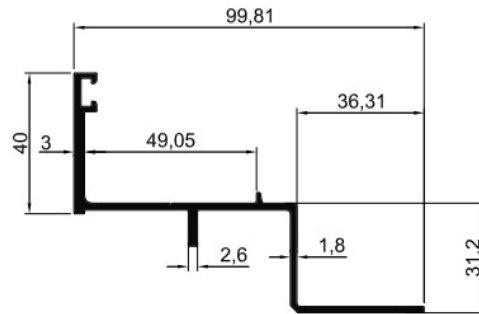

SI NO	SECTION NO.	WEIGHT(KG/M)
1	2736	1.065

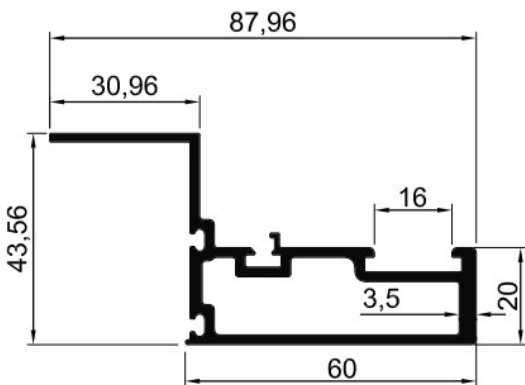

SI NO	SECTION NO.	WEIGHT(KG/M)
1	2738	1.306

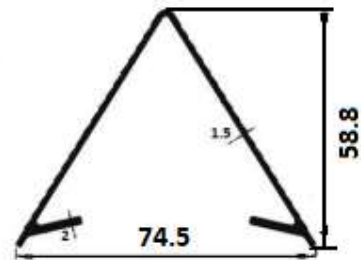

SI NO	SECTION NO.	WEIGHT(KG/M)
1	5539	0.568

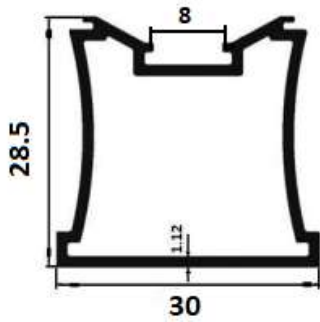

SI NO	SECTION NO.	WEIGHT(KG/M)
1	5545	0.396

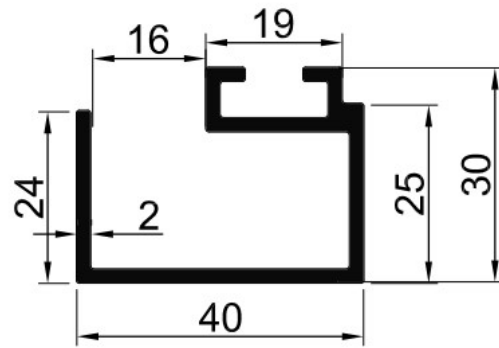

SI NO	SECTION NO.	WEIGHT(KG/M)
1	5549	0.686

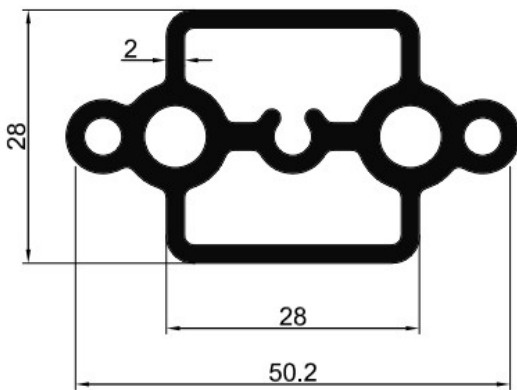

SI NO	SECTION NO.	WEIGHT(KG/M)
1	5581	1.121

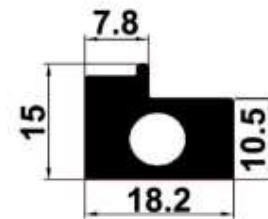

SI NO	SECTION NO.	WEIGHT(KG/M)
1	6100	0.478

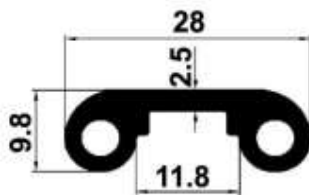

SI NO	SECTION NO.	WEIGHT(KG/M)
1	6102	0.365

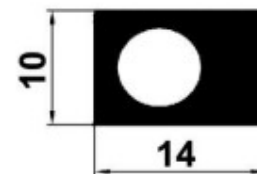

SI NO	SECTION NO.	WEIGHT(KG/M)
1	6104	0.273

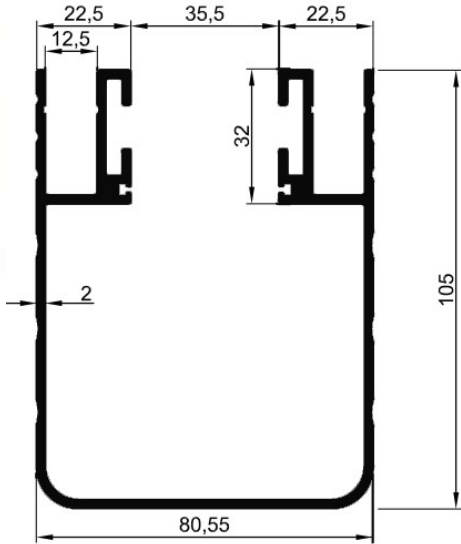

SI NO	SECTION NO.	WEIGHT(KG/M)
1	6106	2.304

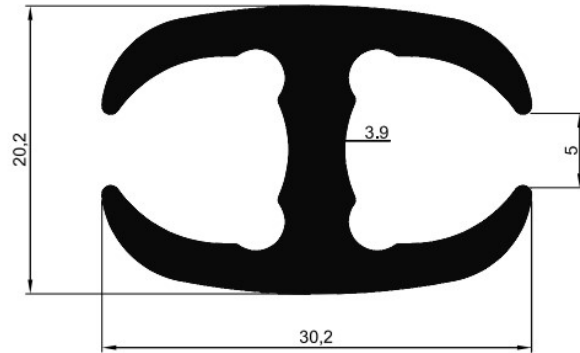

SI NO	SECTION NO.	WEIGHT(KG/M)
1	6108	0.689

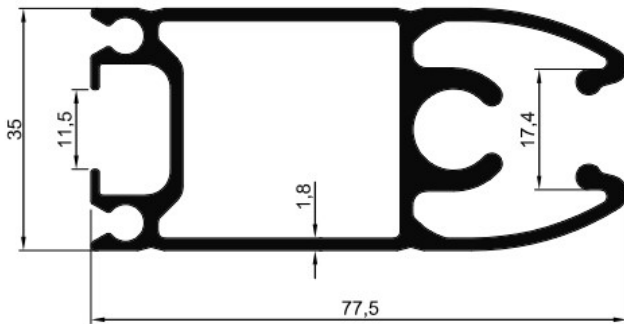

SI NO	SECTION NO.	WEIGHT(KG/M)
1	6110	1.616

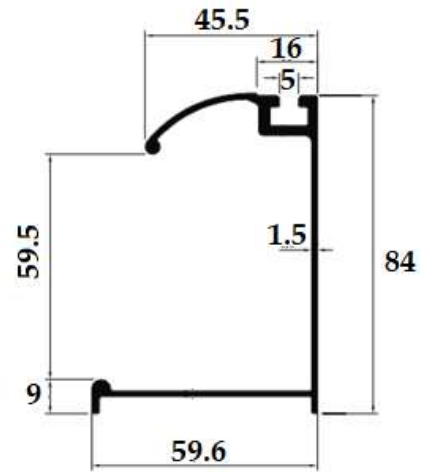

SI NO	SECTION NO.	WEIGHT(KG/M)
1	6201	1.022

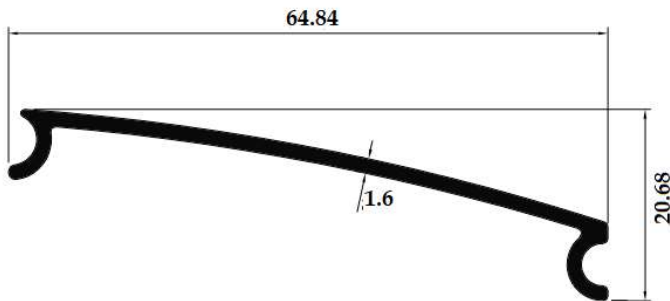

SI NO	SECTION NO.	WEIGHT(KG/M)
1	6202	0.351

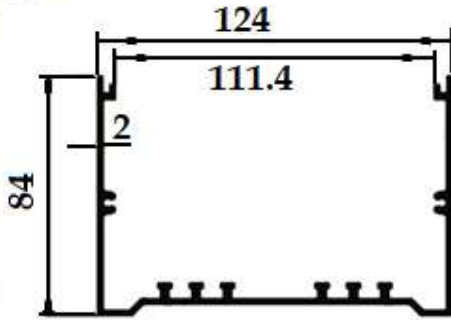

SI NO	SECTION NO.	WEIGHT(KG/M)
1	6203	2.103

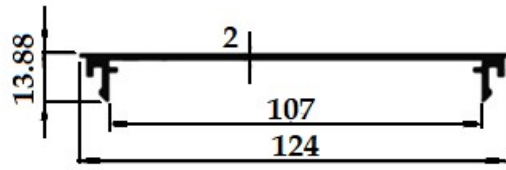

SI NO	SECTION NO.	WEIGHT(KG/M)
1	6204	0.893



SI NO	SECTION NO.	WEIGHT(KG/M)
1	9035	0.465

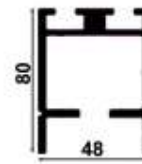

SI NO	SECTION NO.	WEIGHT(KG/M)
1	9055	2.187

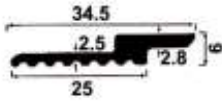

SI NO	SECTION NO.	WEIGHT(KG/M)
1	9064	0.247



SI NO	SECTION NO.	WEIGHT(KG/M)
1	9078	0.492

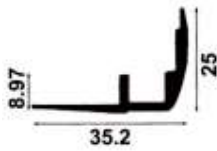

SI NO	SECTION NO.	WEIGHT(KG/M)
1	9081	0.300

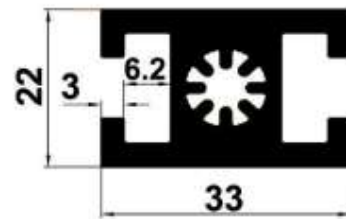

SI NO	SECTION NO.	WEIGHT(KG/M)
1	9088	1.137

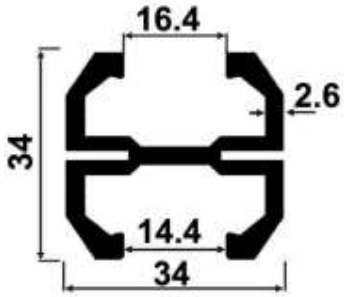

SI NO	SECTION NO.	WEIGHT(KG/M)
1	9101	0.867

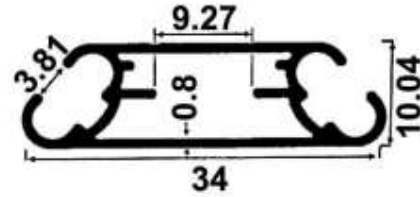

SI NO	SECTION NO.	WEIGHT(KG/M)
1	9110	0.300

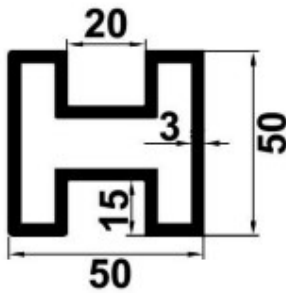

SI NO	SECTION NO.	WEIGHT(KG/M)
1	9125	2.005

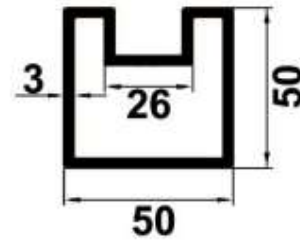

SI NO	SECTION NO.	WEIGHT(KG/M)
1	9126	1.763

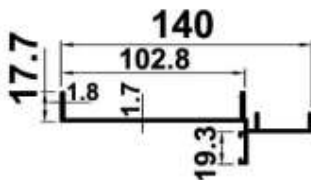

SI NO	SECTION NO.	WEIGHT(KG/M)
1	9403	1.047

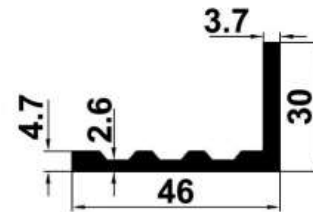

SI NO	SECTION NO.	WEIGHT(KG/M)
1	9205	0.674

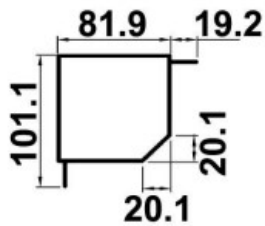

SI NO	SECTION NO.	WEIGHT(KG/M)
1	9401	1.594

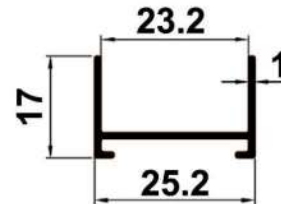

SI NO	SECTION NO.	WEIGHT(KG/M)
1	9701	0.165

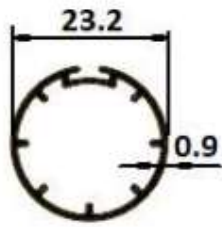

SI NO	SECTION NO.	WEIGHT(KG/M)
1	8026	0.212